

## XA16BU

### XA – Terminals Extra Long & Away from spindle

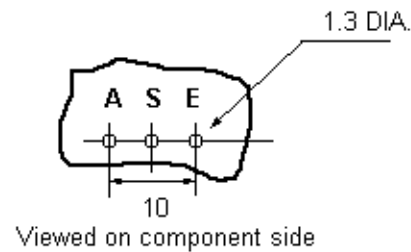

SPINDLE END VIEW

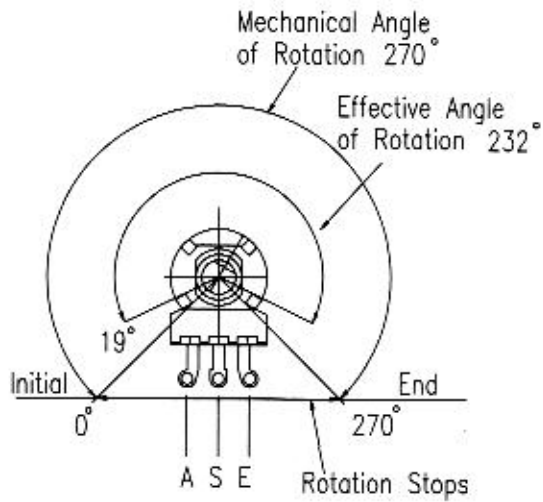
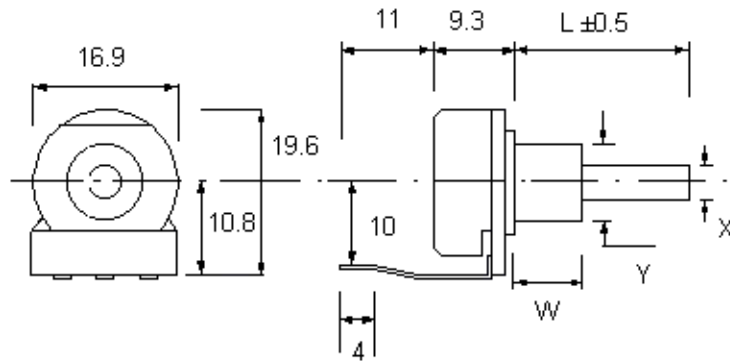

- W Mounting Height
- Y Mounting Diameter
- X Spindle Diameter
- L Spindle Length
  
- A Initial Termination
- S Wiper (or moving contact) termination
- E End Termination

---

## Technical Data

Rated Power Dissipation @40°C for P16 potentiometers:

0.25W linear law

0.12W nonlinear law

Conductive polymer (plastic) track (over twice the life of carbon tracks)

Effective rotation: 232° nominal

Operating Torque: 0.4 – 1.5 cN.m

Permissible Axial Spindle Load: 50 N (5 Sec. maximum)

Permissible Torque at End Stop: 35 cN.m

Rotation angle: 270° ±5°

Optional Click stop (indents) for rotational tactile feedback

Rotational torque of spindle can be made high or low

The potentiometer terminals are marked A, S and E.

Life Expectancy of >20,000 cycles (tested at 30 times per minute)

Insulation Resistance: >= 4 Gohms

Rated Resistance: E3 Series

Optional: E6 Series

Linear Law: 1K – 1M

Nonlinear Law: 4K7 – 470K

---

## ELECTRICAL SPECIFICATION COMMON TO ALL POTENTIOMETERS

Conductive polymer (plastic) track (over twice the life of carbon tracks)

Life Expectancy of >20,000 cycles (tested at 30 times per minute)

Insulation Resistance: >= 4 Gohms

Rated Resistance: E3 Series

- Optional: E6 Series
- Linear Law: 1K - 1M
- Nonlinear Law: 4K7 - 470K

Tolerance on Rated Resistance: ± 20%

- Optional Tolerance on 1K - 1M: ± 10%

Resistance Laws (Taper):

- Linear: A
- Nonlinear: B - Log (Audio) or C - Antilog (Reverse Audio)
- Other laws: Please refer to Sales office

## ELECTRICAL SPECIFICATION UNIQUE TO P16 POTENTIOMETERS

Effective rotation:

- Without a switch: 232° nominal
- With rotary switch: 232° nominal

Rated Power Dissipation @40°C for ECO potentiometers:

- 0.25W linear law
- 0.12W nonlinear law

### ECO, P16 power dissipating curve

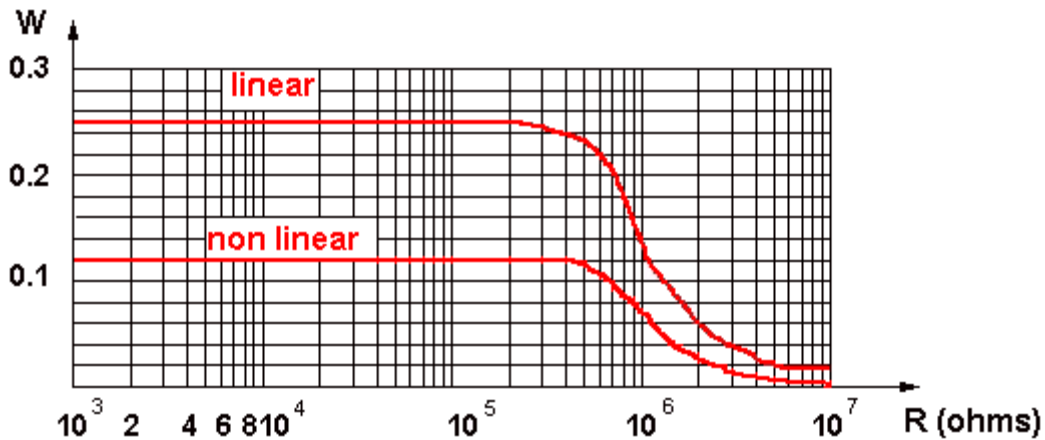

Limiting Element Voltage: 350 V DC for 16mm potentiometers

### ECO, P16 maximum working voltage curve

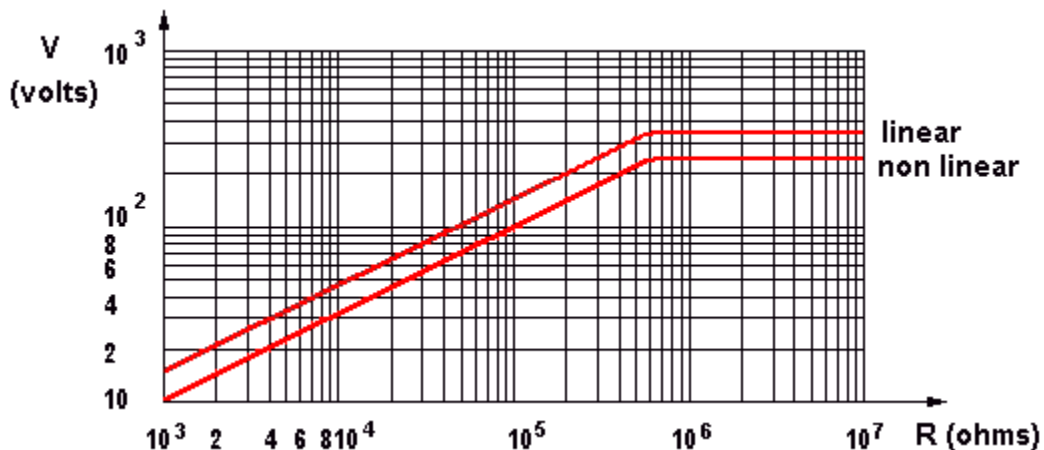

Insulating Voltage: 500 V AC for ECO potentiometers

### Resistance law A - Linear

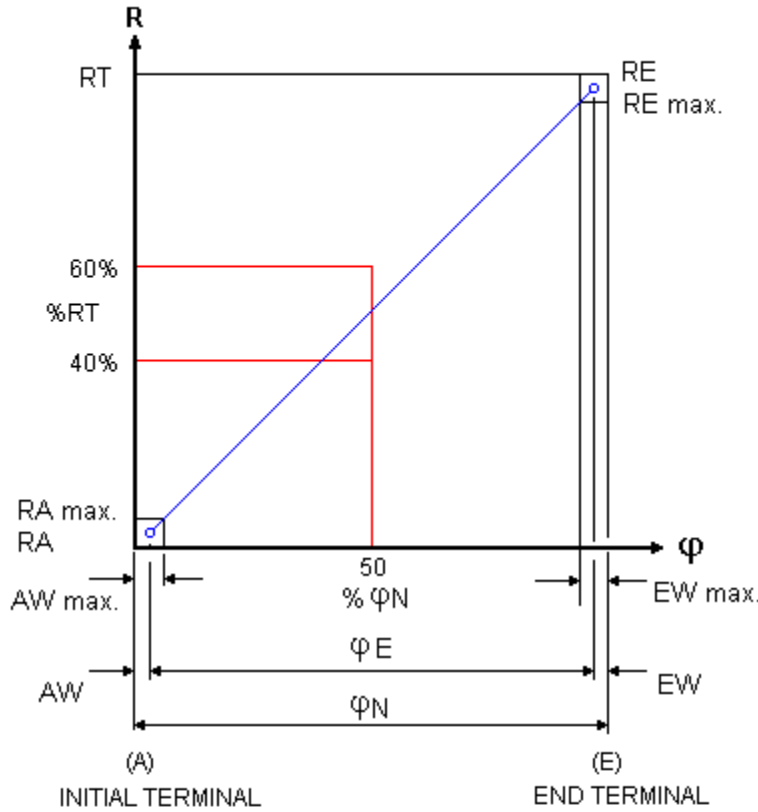

- AW ..... Initial Path ..... AW max. 12% φN
- EW ..... Final Path ..... EW max. 12% φN
- Ra ..... Initial Stop Value .....  $\leq 1 \cdot 10^{-3} RN$  (Minimum 2 ohms)
- RA ..... Hop-on Resistance .....  $\leq 1\% RN$
- Re ..... End Stop Value .....  $\leq 1 \cdot 10^{-3} RN$  (Minimum 2 ohms)
- RE ..... Hop-off Resistance .....  $\leq 1\% RN$
- RN ..... Rated Resistance
- RT ..... Effective Resistance
- φ ..... Rotation Angle
- φE ..... Effective Electrical Angle of Rotation
- φN ..... Effective Mechanical Angle of Rotation

### Resistance law B – Log (Audio)

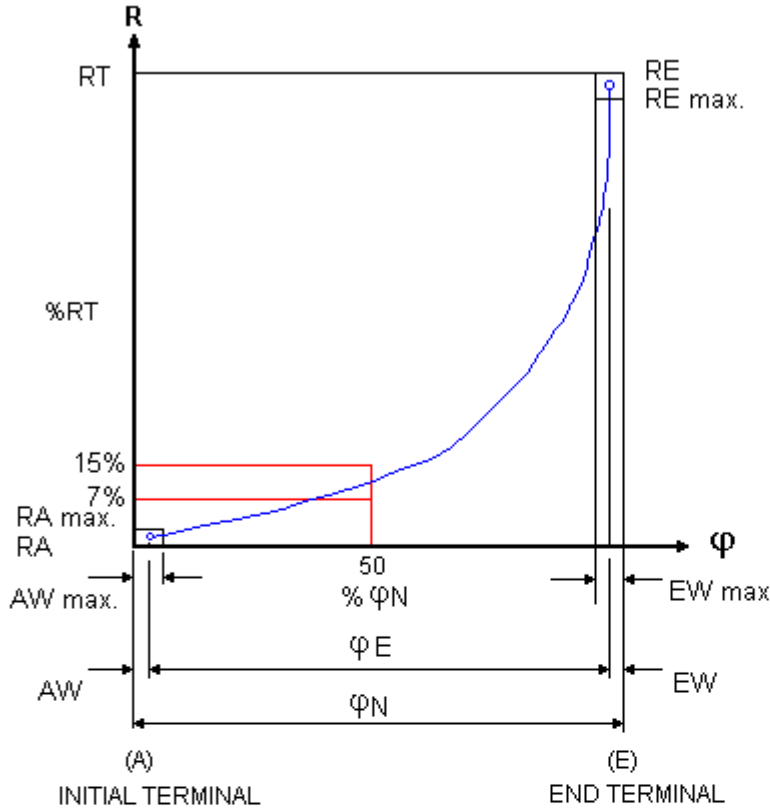

AW	Initial Path	AW max. 10% φN
EW	Final Path	EW max. 10% φN
Ra	Initial Stop Value	RN ≤ 10K ≤ 1.10 <sup>-3</sup> RN (Minimum 2 ohms) RN > 10K ≤ 2.10 <sup>-4</sup> RN (Minimum 10 ohms)
RA	Hop-on Resistance	RN ≤ 10K 5% RN RN > 10K 0.15% RN
Re	End Stop Value	RN ≤ 100K ≤ 2.10 <sup>-2</sup> RN RN > 100K ≤ 1.10 <sup>-2</sup> RN
RE	Hop-off Resistance	RN ≤ 10K < 1% RN RN > 10K 0.5% RN
RN	Rated Resistance	
RT	Effective Resistance	
φ	Rotation Angle	
φE	Effective Electrical Angle of Rotation	
φN	Effective Mechanical Angle of Rotation	

### Resistance law C – Antilog (Reverse Audio)

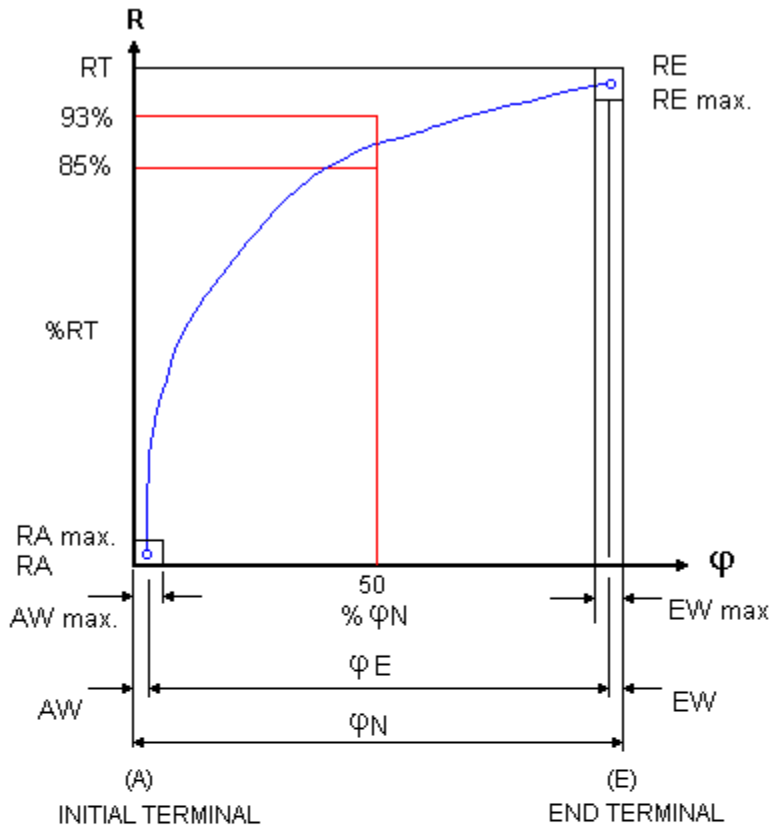

AW	Initial Path	AW max. 10% $\phi_N$
EW	Final Path	EW max. 10% $\phi_N$
Ra	Initial Stop Value	$R_N \leq 100K \leq 2.10^{-2} R_N$ $R_N > 100K \leq 1.10^{-2} R_N$
RA	Hop-on Resistance	$R_N \leq 10K < 1\% R_N$ $R_N > 10K 0.5\% R_N$
Re	End Stop Value	$R_N \leq 10K \leq 1.10^{-3} R_N$ (Minimum 2 ohms) $R_N > 10K \leq 2.10^{-4} R_N$ (Minimum 10 ohms)
RE	Hop-off Resistance	$R_N \leq 10K 5\% R_N$ $R_N > 10K 0.15\% R_N$
RN	Rated Resistance	
RT	Effective Resistance	
$\phi$	Rotation Angle	
$\phi E$	Effective Electrical Angle of Rotation	
$\phi N$	Effective Mechanical Angle of Rotation	

## Linearity

As a basis of assessing Linearity Tolerance the independent method is the most practical, permitting as it does, the reference curve to be aligned as near as possible to the actual output curve. This avoids the use of the theoretical starting and finishing points, it is normal for the customer to realign the achieved curve with series trimmers at each end of the device if required.

Linearity Tolerance is 4% over the Nominal Resistance range of 1K0 to 1M0. The Linearity Tolerance is measured on at least 70% of the effective rotation range.

Note. In the case of Terminal and Zero-based linearity, both present constraints which increase the manufacturing difficulty and in consequence have an adverse effect on the product's price and availability.

### Potentiometer linearity

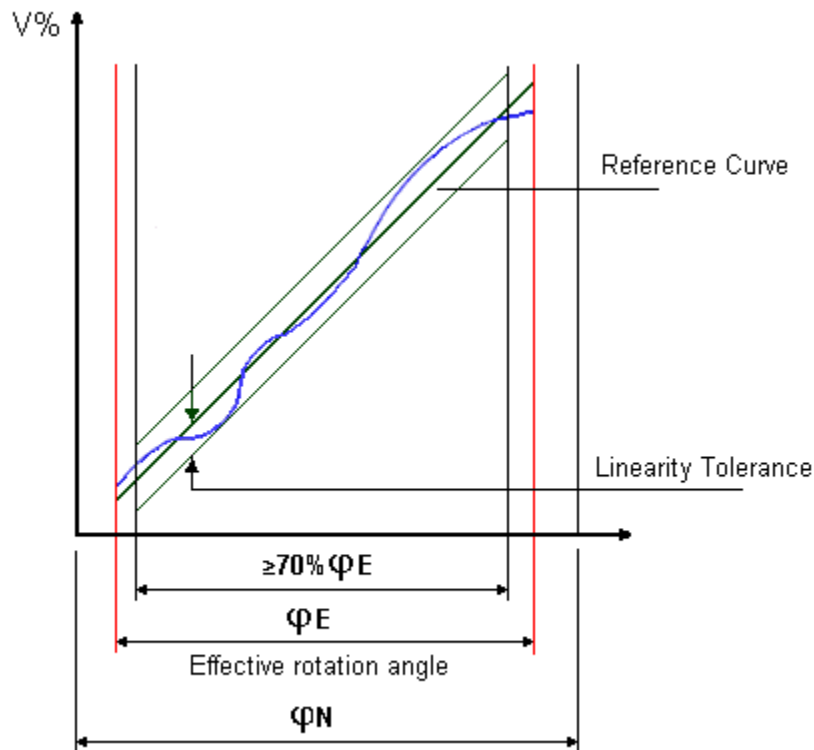

#### Matching Tolerance (For Tandem Stereo Potentiometers)

Tandem Potentiometers have two identical resistor units with the same variation law. The mismatching of the two resistor units, expressed in dB, is measured by the difference between the attenuations introduced by each resistor unit at various points of travel.

- Law A: 4 dB at Attenuation range 0 - 20 dB
- Law B and C: 3 dB at Attenuation range 0 - 20 dB

### Matched Tolerance for Stereo

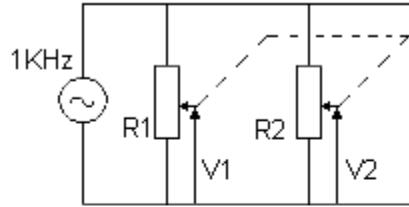

LAW	ATTENUATION RANGE	MATCHING TOLERANCE *
A	0 - 20dB	4dB
B & C	0 - 20dB	3dB

\*Matching Tolerance =  $20 \text{ Log } \frac{V1}{V2}$

Operating Temperature: -25°C to +70°C

### Temperature Derating Curve

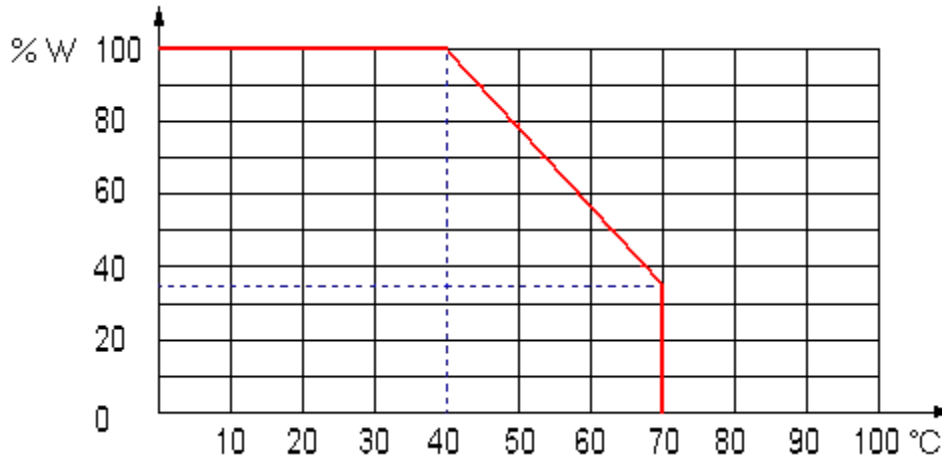

Temperature Coefficient of Resistance: +300 -500 ppm



## Components

### P16 Bush Housing (Mounting)

The P16 bushes are available in metal or nylon with an M7 or M10 thread both with and without a locating feature:

Diecast Zinc Alloy M10 x 0.75mm pitch (Type C) or M7 0.75mm pitch (Type CG)  
 Glass Filled Nylon M10 x 0.75mm pitch (Type CP)

Do not attempt to prevent any unwanted body rotation by overtightening the retaining nut, since this can cause thread damage, distortion, change of electrical resistance and restrict shaft rotation. BS9130:1972 provides further details on this topic. The **recommended torque** for tightening the retaining nut is 45cN.m and this can be achieved cost effectively by using a Torque Limiting device as shown on our **Accessories** page.

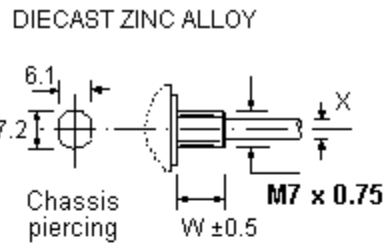

TYPE CG (without locator)	
<b>X (mm)</b>	<b>4</b>
<b>W (mm)</b>	<b>6</b>

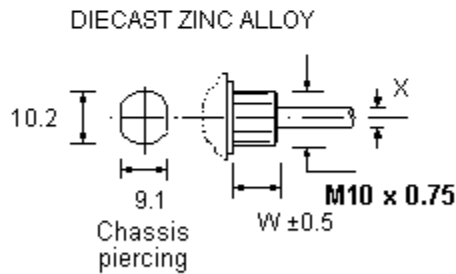

TYPE C (without locator)	
<b>X (mm)</b>	<b>6 or 6.35</b>
<b>W (mm)</b>	<b>8</b>

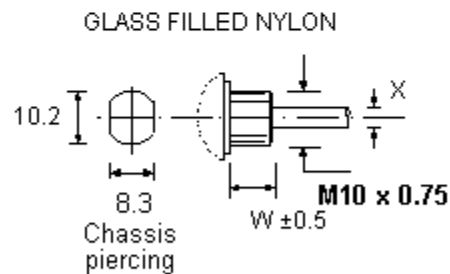

TYPE CP (GFN)	
<b>X (mm)</b>	<b>4 or 6</b>
<b>W (mm)</b>	<b>8</b>



## **P16 Spindles**

The P16 spindles are plastic, unless otherwise stated, fixed i.e. not removable and they are available in three diameters:

- 6.0mm Diameter
  - Cylindrical (Type F1)
  - 4.0 x 12mm Flat (Type F2)
  - 5.0 x 15mm Flat (Type F3)
  - 5.0 x 10mm Flat (Type F4)
  - 4.6mm x 15mm Flat (Type F11)
- 4.0mm Diameter
  - 3.0 x 8.5mm Flat (Type F22)
  - 3.0 x 8.5mm Flat (Type M22 - Metal)
- 6.35mm Diameter
  - Cylindrical (Type F41)
  - 5.5 x 10mm Flat (Type F42)
  - 5.5 x 15mm Flat (Type F43)
- Splined Spindle - 6.0mm dia. 18 teeth
- Dual Concentric
  - Flatted/Slotted (Type M15 - Metal)
  - Cylindrical (Type M16 - Metal)

## Cylindrical and Flatted Spindles

### 6.0mm Diameter Spindles

Note: \*Specials to customer's specification up to 65mm.

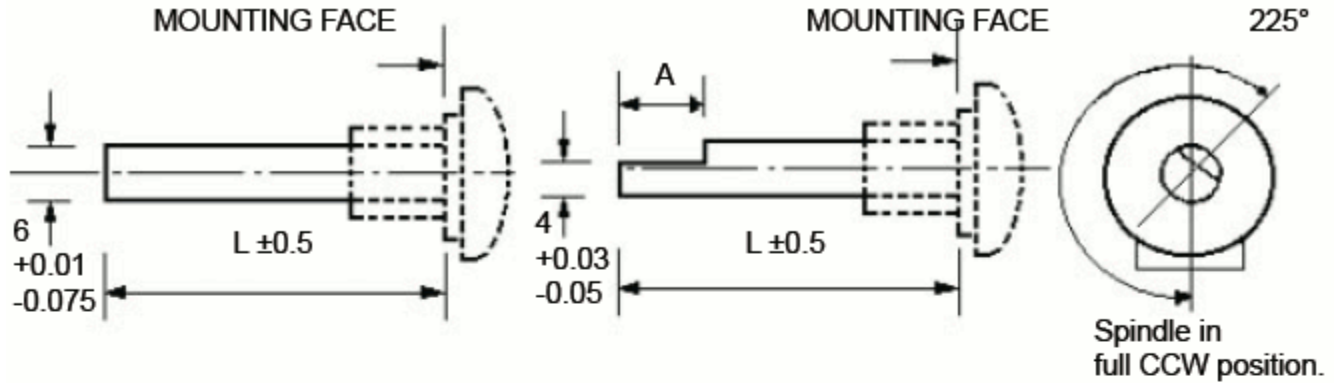

TYPE	DESC.	L (mm)
F1	Plastic Fixed	15 to 50*

TYPE	DESC.	L (mm)	A (mm)
F2	Plastic Fixed	20 to 35*	12

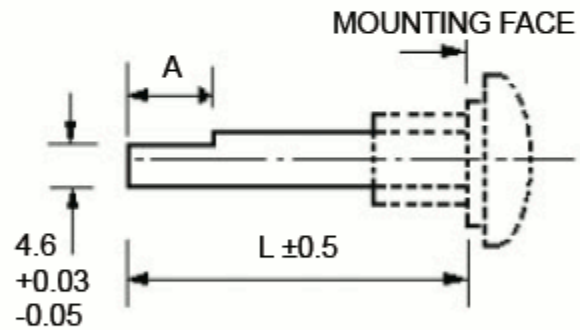
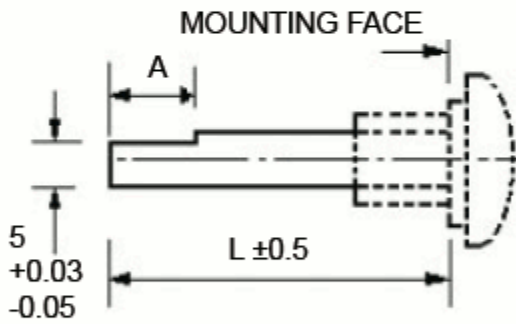

TYPE	DESC.	L (mm)	A (mm)
F3	Plastic Fixed	15 to 35*	15
F4	Plastic Fixed	15 to 35*	10

TYPE	DESC.	L (mm)	A (mm)
F11	Plastic Fixed	15 to 35*	15

### 4.0mm Diameter Spindles

Note: The orientation of the flat as illustrated is for plastic spindles only.  
 For metal spindles, unless specified on the order, the orientation may be different on each

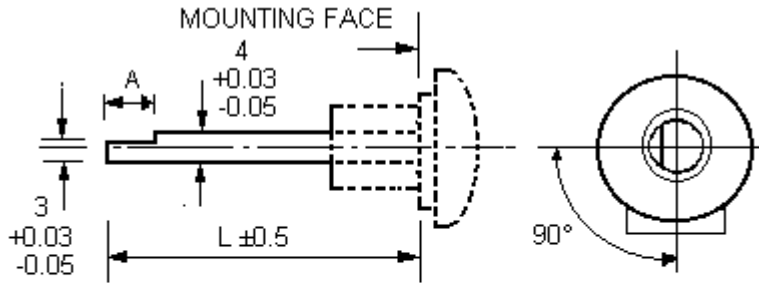

TYPE	DESC.	L (mm)	A (mm)
F22	Plastic Fixed	15, 20 or 35	8.5
M22	Metal Fixed	15	8.5

Spindle in full CCW position

potentiometer type.

### 6.35mm Diameter Spindles

Note: \*Specials to customer's specification up to 65mm.

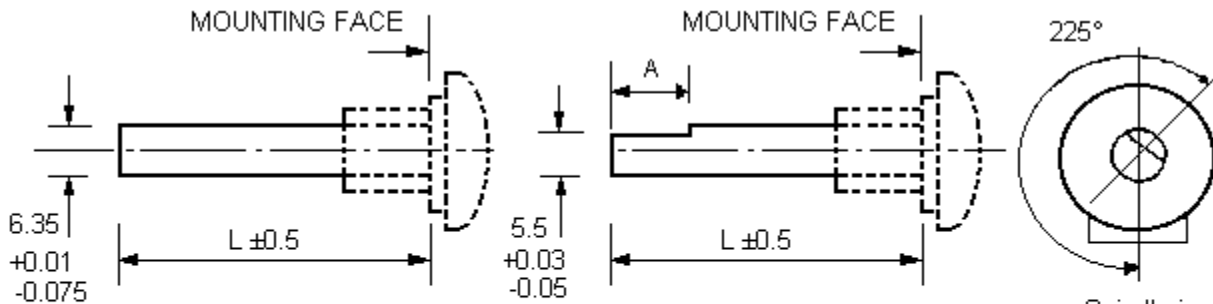

TYPE	DESC.	L (mm)
F41	Plastic Fixed	15 to 35*

TYPE	DESC.	L (mm)	A (mm)
F42	Plastic Fixed	15 to 35*	10
F43	Plastic Fixed	15 to 35*	15

Spindle in full CCW position

**Splined Spindle - 6.0mm dia. 18 teeth**

A splined form is available on the 6.0mm diameter P16 plastic spindle (F5) or alternatively, a 6mm 'Splined Adaptor' (8.7mm long) can be fitted on a 4mm dia. Spindle (F5A):

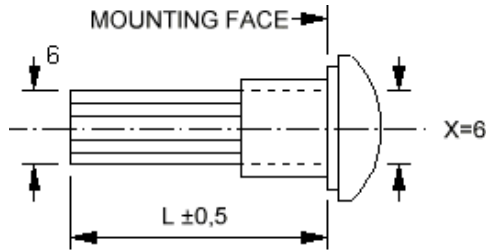

TYPE	DESC.	L (mm)
F5	Plastic Fixed	19

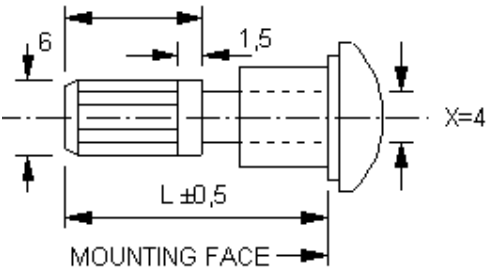
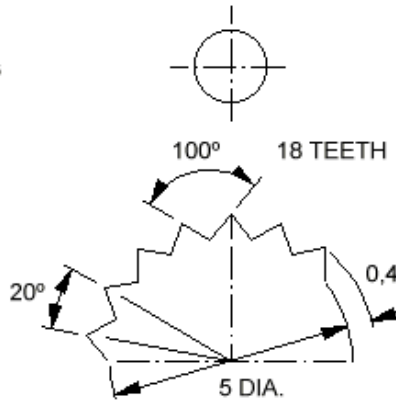

TYPE	DESC.	L (mm)
F5A	Plastic Fixed	16-36

