

# CP20 SERVO

## Precision Potentiometer

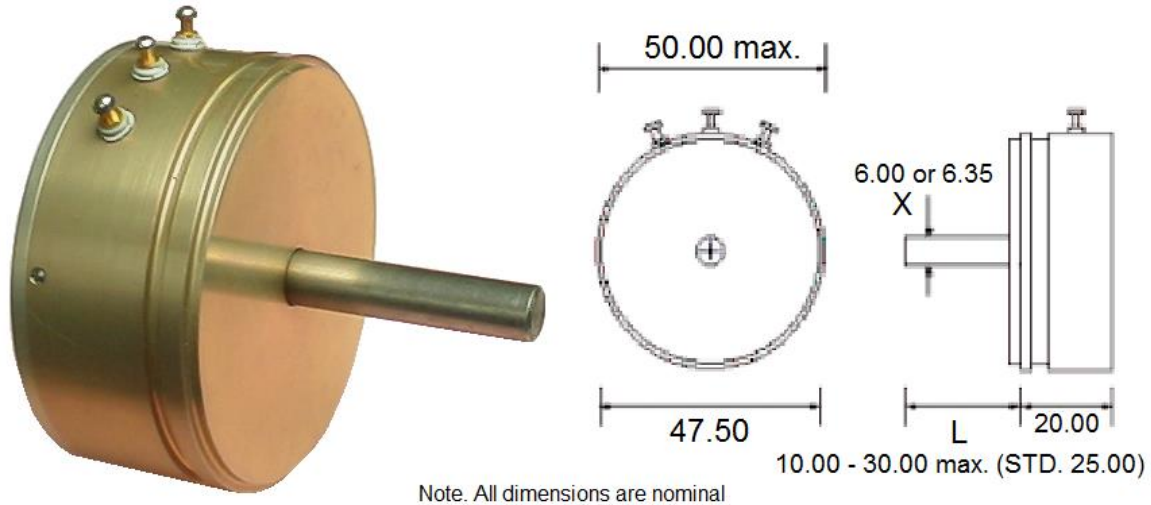

The servo potentiometers are constructed with a precision ball bearing system and long life flush bonded conductive track. The wipers have multiple fingers to achieve low contact resistance. The Resistive Element is Conductive Plastic (CP)

Mountings are by bush and locknut, servo clamp or 3 hole fixing on the front face. A centre tap is available to special order.

To Order we require:

Model(CP20)/Resistance/Angle/Diameter(X)/Length(L)

See diagram above for (X) and (L)

See Technical data below for other information

### Technical Data

Electrical Data		Mechanical Data	
Resistance Range	1K to 50K	Mechanical Rotation	360° continuous
Resistance Tolerance	±10%	Electrical Angle	300, 90°
Independent Linearity	1% standard	Starting Torque	10 gm-cm Max.
Power Dissipation at 20°C	5.0 W	Wiper Velocity	1200°/sec Max. (200 rpm)
Insulation Resistance	50 M ohms At 500V dc	Life	>10 million cycles
Dielectric Strength	1000 V rms	Temperature Range	- 20° C to +120° C
Temperature Coefficient	±300 ppm/°C		