

PC2C20BU

PC – Printed Circuit Terminals

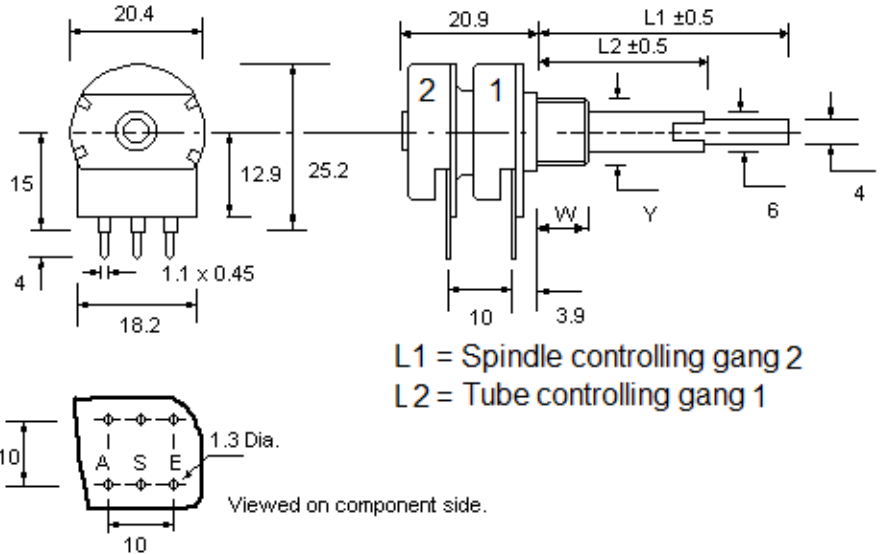

SPINDLE END VIEW

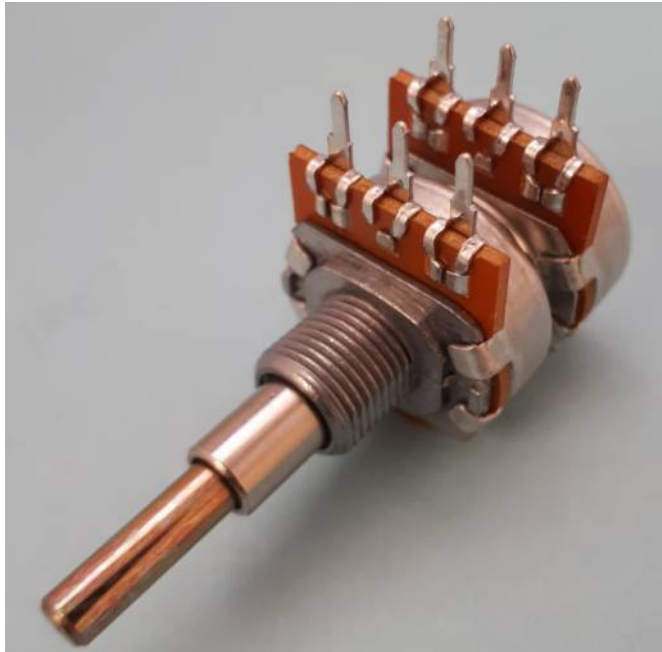
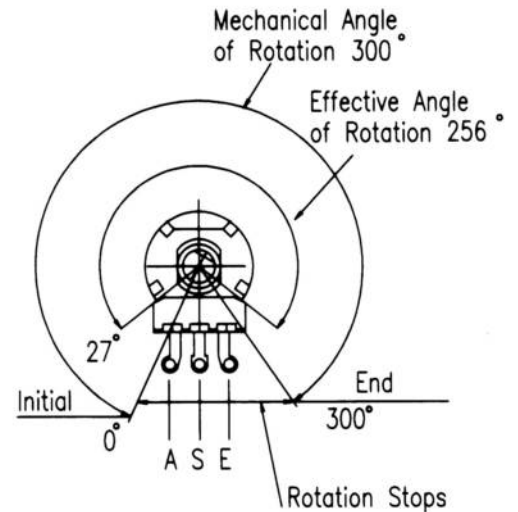

- W Mounting Height
- Y Mounting Diameter
- X Spindle Diameter
- L Spindle Length

- A Initial Termination
- S Wiper (or moving contact) termination
- E End Termination

Prefix (Potentiometer terminals)

- BR - Bracket (included with printed circuit terminals)
- FN - Faston (or spade)
- LA - Long bent and away from the spindle
- LT - Long bent and towards the spindle
- OW - Ordinary wiring (eyelets) - **recommended for hand soldering of wires**
- PC - Printed circuit
- XA - Extra long, bent away from the spindle (mainly used with switches)

Total mechanical and effective electrical angles of rotation of potentiometers without rotary switch

Technical Data

Rated Power Dissipation @40°C for P20 potentiometers:

0.4W linear law

0.2W nonlinear law

Conductive polymer (plastic) track (over twice the life of carbon tracks)

Effective rotation: 256° nominal

Operating Torque: 0.4 – 1.5 cN.m

Permissible Axial Spindle Load: 100 N (5 Sec. maximum)

Permissible Torque at End Stop: 80 cN.m

Rotation angle: 300° ±5°

Rotational torque of spindle can be made high or low

Life Expectancy of >20,000 cycles (tested at 30 times per minute)

Insulation Resistance: >= 4 Gohms

Rated Resistance: E3 Series

Optional: E6 Series

Linear Law: 1K – 1M (±10%)

Nonlinear Law: 4K7 – 470K

ELECTRICAL SPECIFICATION COMMON TO ALL POTENTIOMETERS

Conductive polymer (plastic) track (over twice the life of carbon tracks)

Life Expectancy of >20,000 cycles (tested at 30 times per minute)

Insulation Resistance: >= 4 Gohms

Rated Resistance: E3 Series

- Optional: E6 Series
- Linear Law: 1K - 1M
- Nonlinear Law: 4K7 - 470K

Tolerance on Rated Resistance: ± 20%

- Optional Tolerance on 1K - 1M: ± 10%

Resistance Laws (Taper):

- Linear: A
- Nonlinear: B - Log (Audio) or C - Antilog (Reverse Audio)
- Other laws: Please refer to Sales office

ELECTRICAL SPECIFICATION UNIQUE TO P20 POTENTIOMETERS

Effective rotation:

- Without a switch: 256° nominal
- With switch: 243° nominal
- With rotary switch: 243° nominal

Rated Power Dissipation @40°C for P20 potentiometers:

- 0.4W linear law
- 0.2W nonlinear law

P20 power dissipating curve

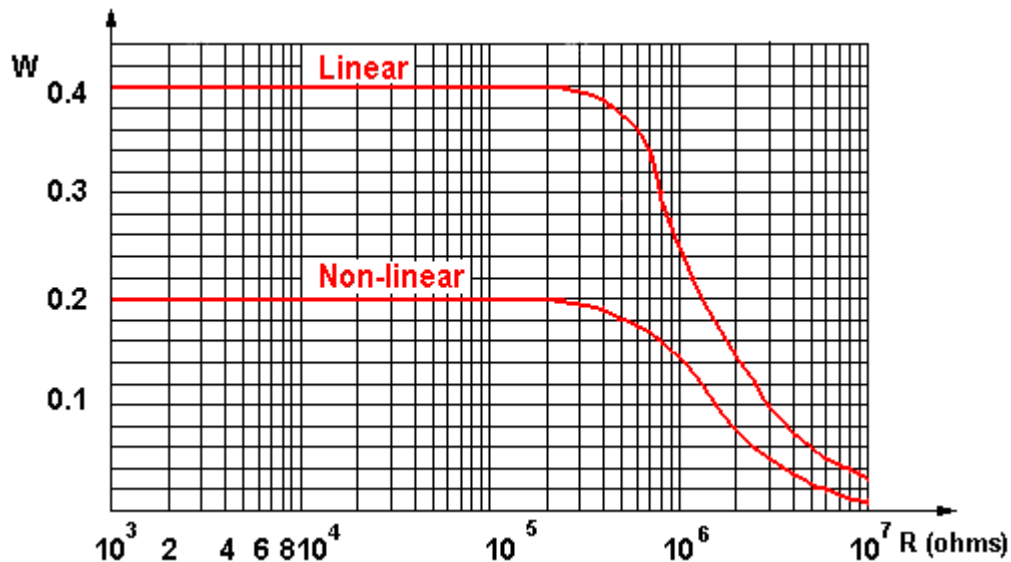

Limiting Element Voltage: 500 V DC for 20mm potentiometers

P20 maximum working voltage curve

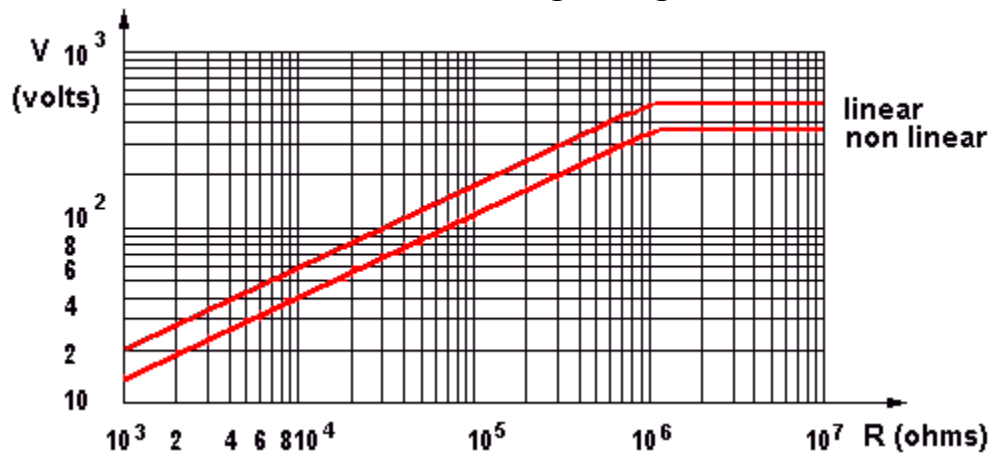

Insulating Voltage: 1000 V AC for 20mm potentiometers

Resistance law A - Linear

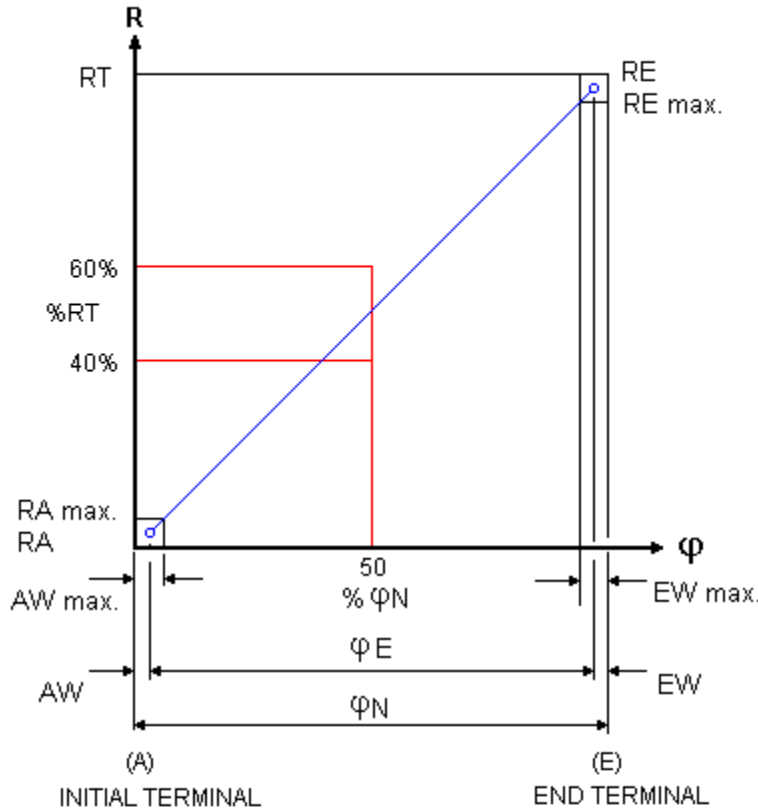

- AW Initial Path AW max. 12% φ_N
- EW Final Path EW max. 12% φ_N
- Ra Initial Stop Value $\leq 1 \cdot 10^{-3} RN$ (Minimum 2 ohms)
- RA Hop-on Resistance $\leq 1\% RN$
- Re End Stop Value $\leq 1 \cdot 10^{-3} RN$ (Minimum 2 ohms)
- RE Hop-off Resistance $\leq 1\% RN$
- RN Rated Resistance
- RT Effective Resistance
- φ Rotation Angle
- φE Effective Electrical Angle of Rotation
- φN Effective Mechanical Angle of Rotation



Resistance law B – Log (Audio)

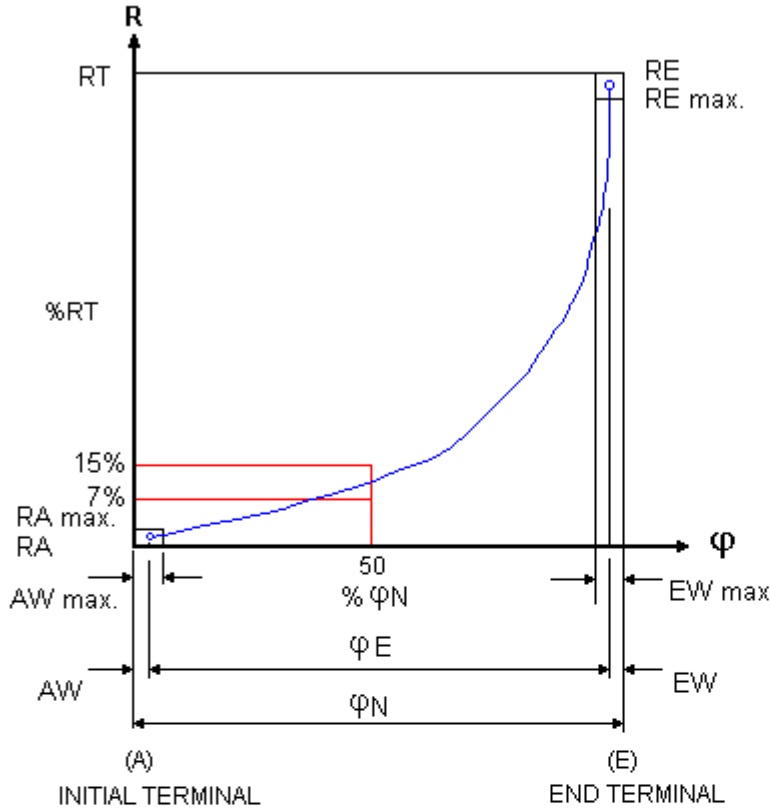

| | | |
|----|--|---|
| AW | Initial Path | AW max. 10% φN |
| EW | Final Path | EW max. 10% φN |
| Ra | Initial Stop Value | RN ≤ 10K ≤ 1.10 ⁻³ RN (Minimum 2 ohms) RN > 10K ≤ 2.10 ⁻⁴ RN (Minimum 10 ohms) |
| RA | Hop-on Resistance | RN ≤ 10K 5% RN RN > 10K 0.15% RN |
| Re | End Stop Value | RN ≤ 100K ≤ 2.10 ⁻² RN RN > 100K ≤ 1.10 ⁻² RN |
| RE | Hop-off Resistance | RN ≤ 10K < 1% RN RN > 10K 0.5% RN |
| RN | Rated Resistance | |
| RT | Effective Resistance | |
| φ | Rotation Angle | |
| φE | Effective Electrical Angle of Rotation | |
| φN | Effective Mechanical Angle of Rotation | |

Resistance law C – Antilog (Reverse Audio)

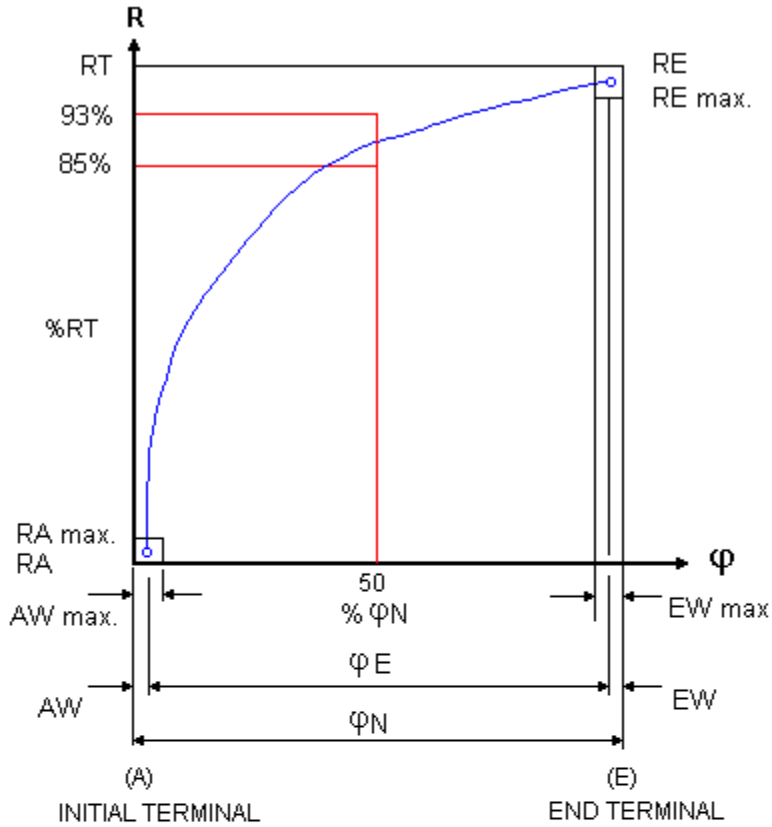

| | | |
|----------|--|--|
| AW | Initial Path | AW max. 10% ϕ_N |
| EW | Final Path | EW max. 10% ϕ_N |
| Ra | Initial Stop Value | $R_N \leq 100K \leq 2.10^{-2} R_N$ $R_N > 100K \leq 1.10^{-2} R_N$ |
| RA | Hop-on Resistance | $R_N \leq 10K < 1\% R_N$ $R_N > 10K 0.5\% R_N$ |
| Re | End Stop Value | $R_N \leq 10K \leq 1.10^{-3} R_N$ (Minimum 2 ohms) $R_N > 10K \leq 2.10^{-4} R_N$ (Minimum 10 ohms) |
| RE | Hop-off Resistance | $R_N \leq 10K 5\% R_N$ $R_N > 10K 0.15\% R_N$ |
| RN | Rated Resistance | |
| RT | Effective Resistance | |
| ϕ | Rotation Angle | |
| ϕE | Effective Electrical Angle of Rotation | |
| ϕN | Effective Mechanical Angle of Rotation | |

Linearity

As a basis of assessing Linearity Tolerance the independent method is the most practical, permitting as it does, the reference curve to be aligned as near as possible to the actual output curve. This avoids the use of the theoretical starting and finishing points, it is normal for the customer to realign the achieved curve with series trimmers at each end of the device if required.

Linearity Tolerance is 4% over the Nominal Resistance range of 1K Ω to 1M Ω . The Linearity Tolerance is measured on at least 70% of the effective rotation range.

Note. In the case of Terminal and Zero-based linearity, both present constraints which increase the manufacturing difficulty and in consequence have an adverse effect on the product's price and availability.

Potentiometer linearity

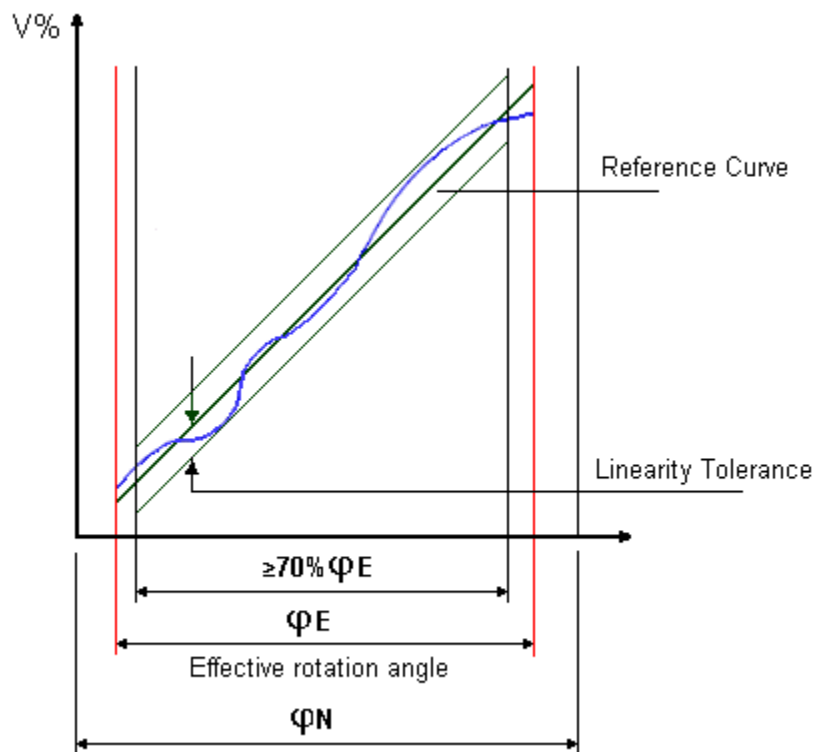

Matching Tolerance (For Tandem Stereo Potentiometers)

Tandem Potentiometers have two identical resistor units with the same variation law. The mismatching of the two resistor units, expressed in dB, is measured by the difference between the attenuations introduced by each resistor unit at various points of travel.

- Law A: 4 dB at Attenuation range 0 - 20 dB
- Law B and C: 3 dB at Attenuation range 0 - 20 dB

Matched Tolerance for Stereo

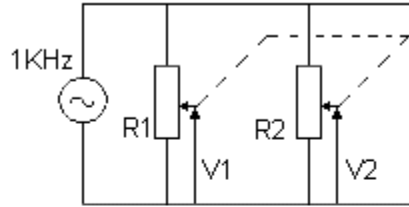

| LAW | ATTENUATION RANGE | MATCHING TOLERANCE * |
|-------|-------------------|----------------------|
| A | 0 - 20dB | 4dB |
| B & C | 0 - 20dB | 3dB |

*Matching Tolerance = $20 \text{ Log } \frac{V1}{V2}$

Operating Temperature: -25°C to +70°C

Temperature Derating Curve

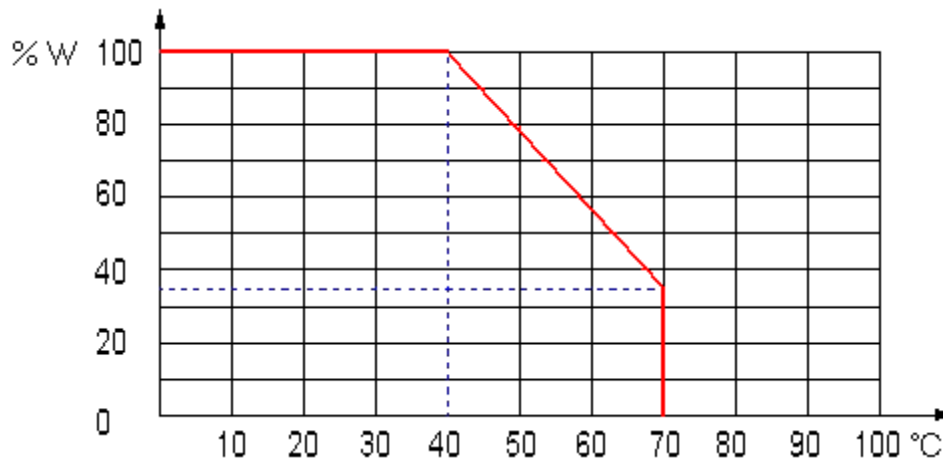

Temperature Coefficient of Resistance: +300 -500 ppm

Components

P20 Bush Housing (Mounting)

The P20 bushes are available in metal or nylon; with three thread options; and with or without a locating feature:

DIECAST ZINC ALLOY

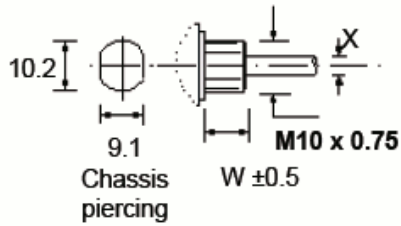

| Type C (without locator) | |
|--------------------------|---|
| X (mm) | 6 |
| W (mm) | 9 |

DIECAST ZINC ALLOY

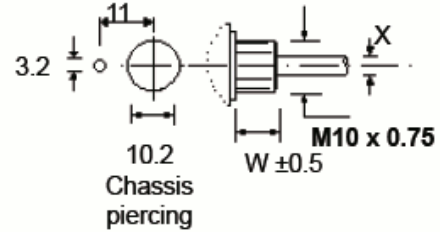

| Type CEBS (with locator) | |
|--------------------------|---|
| X (mm) | 6 |
| W (mm) | 9 |

DIECAST ZINC ALLOY

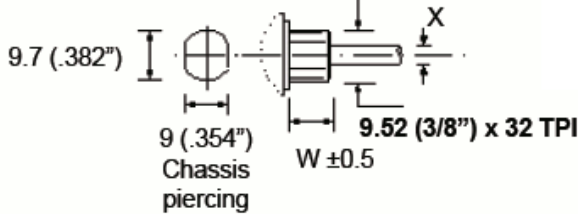

| Type CBS (without locator) | |
|----------------------------|---------|
| X (mm) | 6 |
| W (mm) | 8 or 12 |

GLASS FILLED NYLON

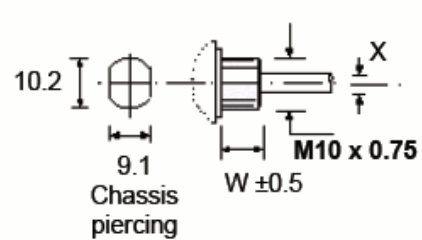

| Type CP (GFN) | | |
|---------------|---------|---------|
| X (mm) | 6 | 6.35 |
| W (mm) | 7 or 10 | 7 or 10 |

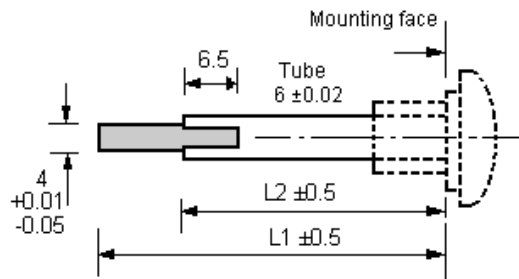

| TYPE | DESC. | L1 (mm) | L2 (mm) |
|------|--------------------|-----------|-----------|
| M15 | Metal Fixed | 60 (max.) | 50 (max.) |