

# XA16ECO/B4PC2S

## B4PC2S - 4 Amp Double Pole (Single Throw) Switch PC – Printed Circuit Terminals

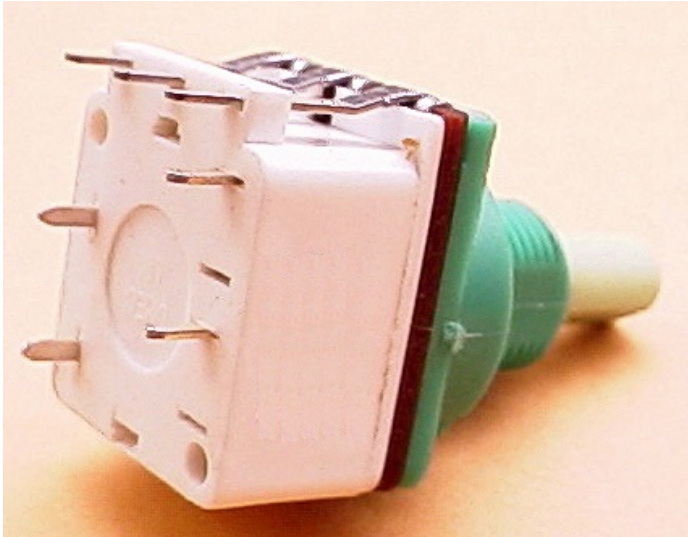

### PRINTED CIRCUIT (PC) TERMINALS on SWITCH

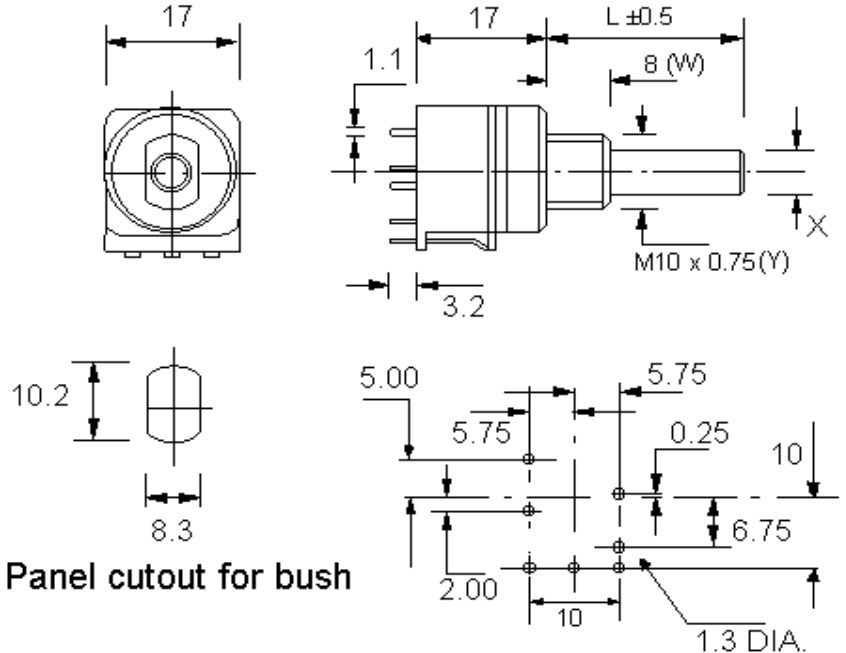

Panel cutout for bush

Viewed on component side

### SPINDLE END VIEW

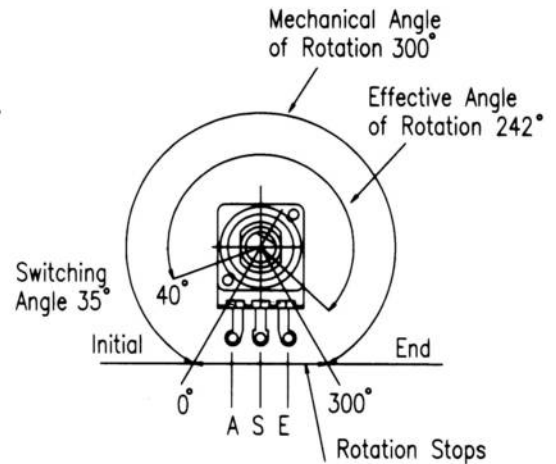

Total mechanical and effective electrical angles of rotation of potentiometers with rotary switch

- W Mounting Height
- Y Mounting Diameter
- X Spindle Diameter
- L Spindle Length
  
- A Initial Termination
- S Wiper (or moving contact) termination
- E End Termination

This image shows the XA terminal located in a fixing lug to restrict movement which is available on request. The standard XA model will be supplied with unrestricted terminals

---

## Technical Data

Rated Power Dissipation @40°C for ECO potentiometers:

0.25W linear law

0.12W nonlinear law

Conductive polymer (plastic) track (over twice the life of carbon tracks)

Effective rotation: 265° nominal

Operating Torque: 0.4 – 1.5 cN.m

Permissible Axial Spindle Load: 50 N (5 Sec. maximum)

Permissible Torque at End Stop: 35 cN.m

Rotation angle: 300° ±5°

Optional Click stop (indents) for rotational tactile feedback

Rotational torque of spindle can be made high or low

Life Expectancy of >20,000 cycles (minimum)

Insulation Resistance: >= 4 Gohms

Rated Resistance: E3 Series

Optional: E6 Series

Linear Law: 1K – 1M

Nonlinear Law: 4K7 – 470K

---

## ELECTRICAL SPECIFICATION COMMON TO ALL POTENTIOMETERS

Conductive polymer (plastic) track (over twice the life of carbon tracks)

Life Expectancy of >25,000 cycles (tested at 30 times per minute)

Insulation Resistance: >= 4 Gohms

Rated Resistance: E3 Series

- Optional: E6 Series
- Linear Law: 1K - 1M
- Nonlinear Law: 4K7 - 470K

Tolerance on Rated Resistance: ± 20%

- Optional Tolerance on 1K - 1M: ± 10%

Resistance Laws (Taper):

- Linear: A
- Nonlinear: B - Log (Audio) or C - Antilog (Reverse Audio)
- Other laws: Please refer to Sales office

---

## Rotary Switch Specification

The rotary switch module is certified by UL International Demko A/S to EN61058-1 with Cenelec Certification Agreement (CCA) and the 1A contact rating is only available when mounted on the ECO potentiometer. NOTE this is a European and NOT an American certification.

### 1A Contact Rating:

Note: The 1A contact rating is NOT available for mounting on the P16 or P20 potentiometer.

1A/250Vac 2.5A/12Vdc

Surge rating (0.01 seconds): 20A

Contact gap: 3mm (Full mains separation of contacts)

### 4A Contact Rating:

4A/250Vac 10A/12Vdc

Surge rating (0.01 seconds): 80A

Switch contacts: Silver tin oxide

Contact gap: 2mm (Micro disconnection of switch - micro separation of contacts)

### Common features

Housing material: Glass filled polyester (UL 94 VO)

Initial contact resistance: 20 milliohms

Insulation resistance: 50,000 Megohms

Life (operations at full load): 10,000 minimum

Operating temperature: -25°C to +70°C

Operating torque for SPST/SPDT: 1.5 - 3 cNm

Operating torque for DPST/DPDT: 3.0 - 6 cNm

Mechanical rotation: 300°

Proof voltage: 3kV minimum

## Rotary Switch Terminals

### Layout

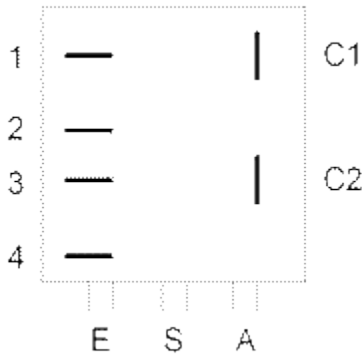
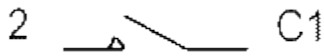

Diagram as viewed on the rear of the switch module:

(Potentiometer terminals at the bottom)

### Configuration



SPST - Single pole (1S), Single throw (On-Off)

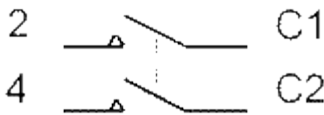

DPST - Double pole (2S), Single throw (On-Off)

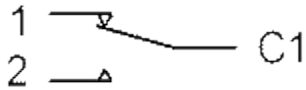

SPDT - Single pole (1S), Double throw (CH)

(**NOT** certified)

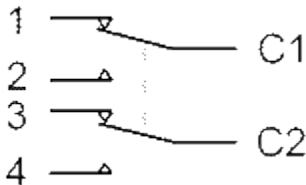

DPDT - Double pole (2S), Double throw (CH)

(**NOT** certified)

### Notes

1. Moving contact(s) shown when the potentiometer shaft is in a counterclockwise (CCW) position.
2. 'Ordinary Wiring'(OW) or 'Printed Circuit'(PC) terminals can be requested on the switch.
3. Terminals 1 and 3 are only fitted for the Double Throw ('CH' or Changeover) versions which are **NOT** approved nor certified.

## Rotary Switch Terminals

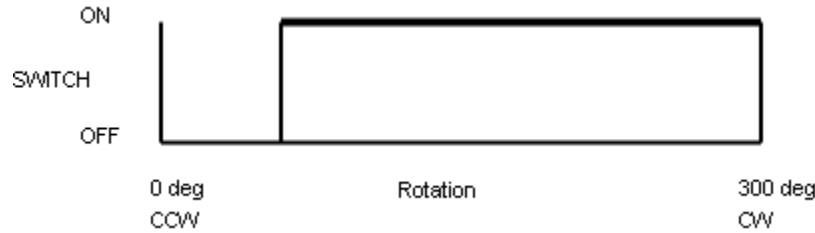

**Standard** (1A or 4A contact ratings)

N/O normally OPEN Switch

Contacts normally OPEN;

CLOCKwise rotation to CLOSE contacts



**Option 1** (4A contact rating only)

N/C normally CLOSED Switch

Contacts normally CLOSED;

CLOCKwise rotation to OPEN contacts

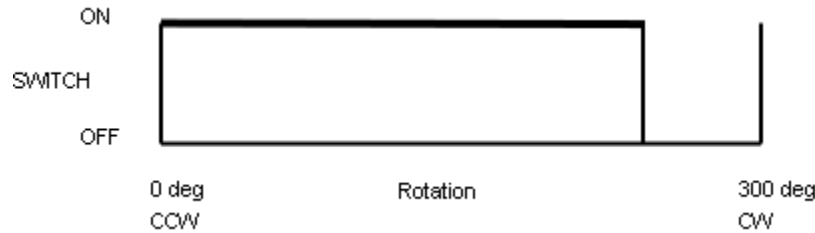

**Option 2** (4A contact rating only)

REVERSED N/O normally OPEN Switch

Contacts normally OPEN at fully clockwise position;

ANTI-clockwise rotation to CLOSE contacts

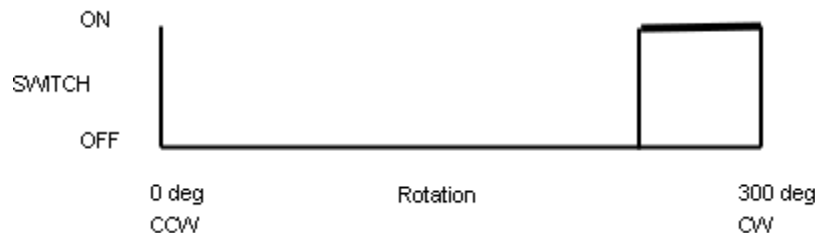

**Option 3** (4A contact rating only)

REVERSED N/C normally CLOSED Switch

Contacts normally CLOSED at fully clockwise position;

ANTI-clockwise rotation to OPEN contacts

## ELECTRICAL SPECIFICATION UNIQUE TO ECO POTENTIOMETERS

Effective rotation:

- Without a switch: 265° nominal
- With push push switch (/10APP, /MS): 265° nominal
- With rotary switch: 242° nominal

Rated Power Dissipation @40°C for ECO potentiometers:

- 0.25W linear law
- 0.12W nonlinear law

### ECO, P16 power dissipating curve

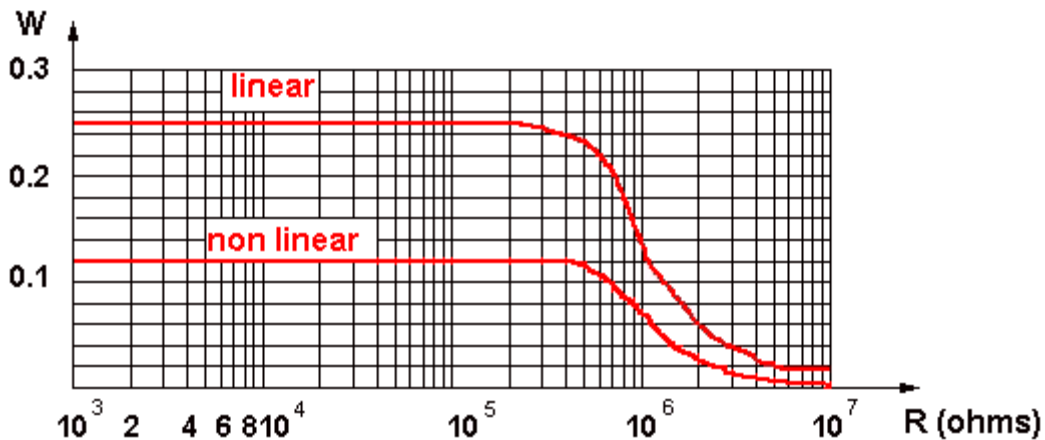

Limiting Element Voltage: 350 V DC for 16mm potentiometers

### ECO, P16 maximum working voltage curve

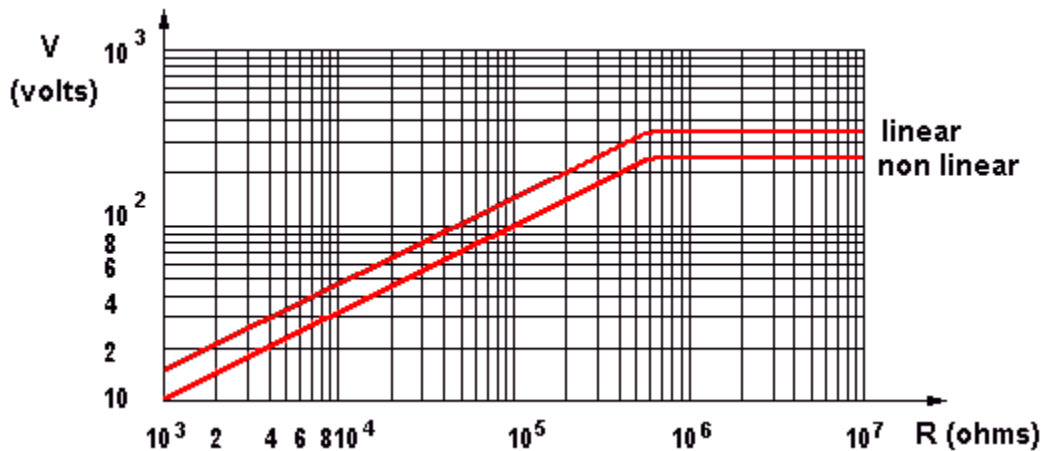

Insulating (Breakdown) Voltage: 2,500 V AC for ECO Potentiometers

### Resistance law A - Linear

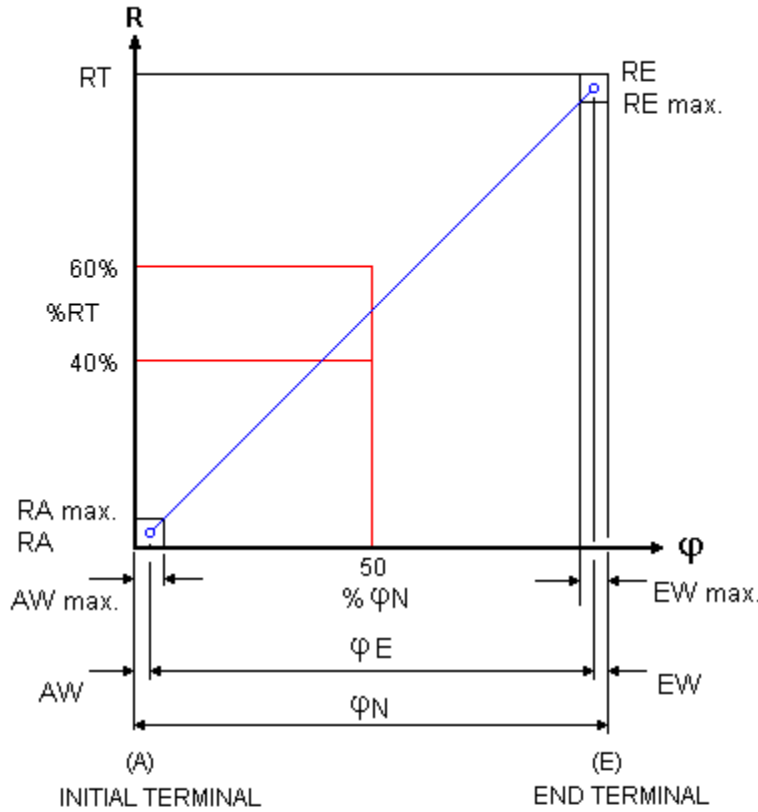

- AW ..... Initial Path ..... AW max. 12% φN
- EW ..... Final Path ..... EW max. 12% φN
- Ra ..... Initial Stop Value .....  $\leq 1 \cdot 10^{-3} RN$  (Minimum 2 ohms)
- RA ..... Hop-on Resistance .....  $\leq 1\% RN$
- Re ..... End Stop Value .....  $\leq 1 \cdot 10^{-3} RN$  (Minimum 2 ohms)
- RE ..... Hop-off Resistance .....  $\leq 1\% RN$
- RN ..... Rated Resistance
- RT ..... Effective Resistance
- φ ..... Rotation Angle
- φE ..... Effective Electrical Angle of Rotation
- φN ..... Effective Mechanical Angle of Rotation

### Resistance law B – Log (Audio)

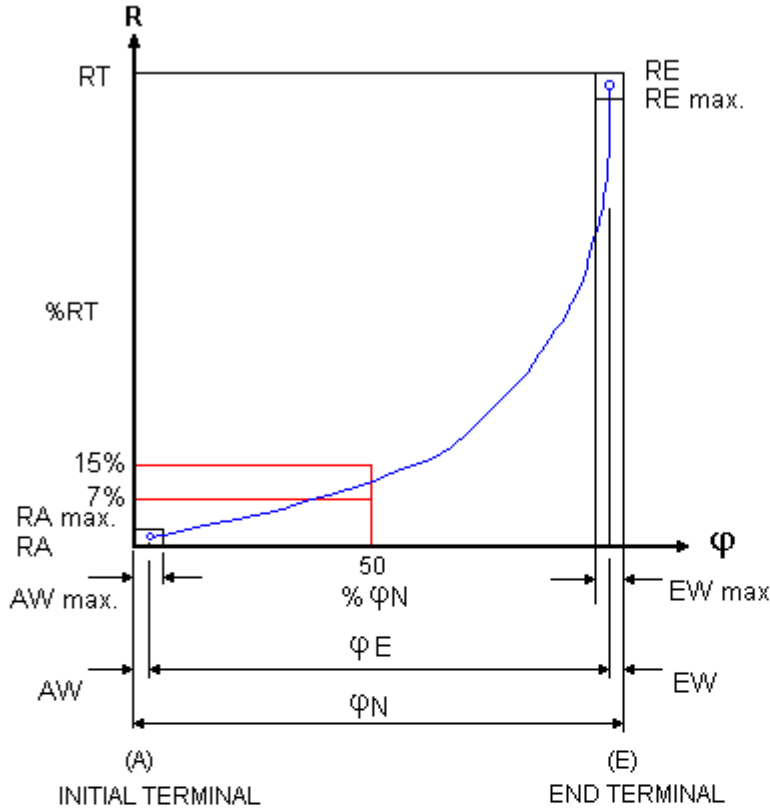

AW	Initial Path	AW max. 10% φN
EW	Final Path	EW max. 10% φN
Ra	Initial Stop Value	RN ≤ 10K ≤ 1.10 <sup>-3</sup> RN (Minimum 2 ohms) RN > 10K ≤ 2.10 <sup>-4</sup> RN (Minimum 10 ohms)
RA	Hop-on Resistance	RN ≤ 10K 5% RN RN > 10K 0.15% RN
Re	End Stop Value	RN ≤ 100K ≤ 2.10 <sup>-2</sup> RN RN > 100K ≤ 1.10 <sup>-2</sup> RN
RE	Hop-off Resistance	RN ≤ 10K < 1% RN RN > 10K 0.5% RN
RN	Rated Resistance	
RT	Effective Resistance	
φ	Rotation Angle	
φE	Effective Electrical Angle of Rotation	
φN	Effective Mechanical Angle of Rotation	



### Resistance law C – Antilog (Reverse Audio)

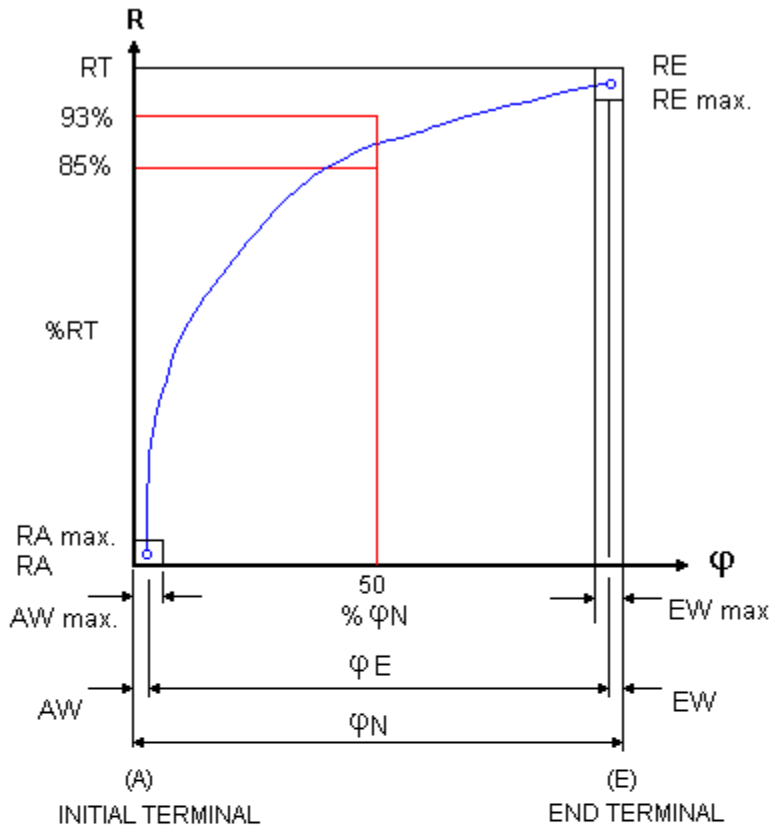

AW	Initial Path	AW max. 10% $\phi_N$
EW	Final Path	EW max. 10% $\phi_N$
Ra	Initial Stop Value	$R_N \leq 100K \leq 2 \cdot 10^{-2} R_N$ $R_N > 100K \leq 1 \cdot 10^{-2} R_N$
RA	Hop-on Resistance	$R_N \leq 10K < 1\% R_N$ $R_N > 10K 0.5\% R_N$
Re	End Stop Value	$R_N \leq 10K \leq 1 \cdot 10^{-3} R_N$ (Minimum 2 ohms) $R_N > 10K \leq 2 \cdot 10^{-4} R_N$ (Minimum 10 ohms)
RE	Hop-off Resistance	$R_N \leq 10K 5\% R_N$ $R_N > 10K 0.15\% R_N$
RN	Rated Resistance	
RT	Effective Resistance	
$\phi$	Rotation Angle	
$\phi E$	Effective Electrical Angle of Rotation	
$\phi N$	Effective Mechanical Angle of Rotation	

## Linearity

As a basis of assessing Linearity Tolerance the independent method is the most practical, permitting as it does, the reference curve to be aligned as near as possible to the actual output curve. This avoids the use of the theoretical starting and finishing points, it is normal for the customer to realign the achieved curve with series trimmers at each end of the device if required.

Linearity Tolerance is 4% over the Nominal Resistance range of 1K $\Omega$  to 1M $\Omega$ . The Linearity Tolerance is measured on at least 70% of the effective rotation range.

Note. In the case of Terminal and Zero-based linearity, both present constraints which increase the manufacturing difficulty and in consequence have an adverse effect on the product's price and availability.

### Potentiometer linearity

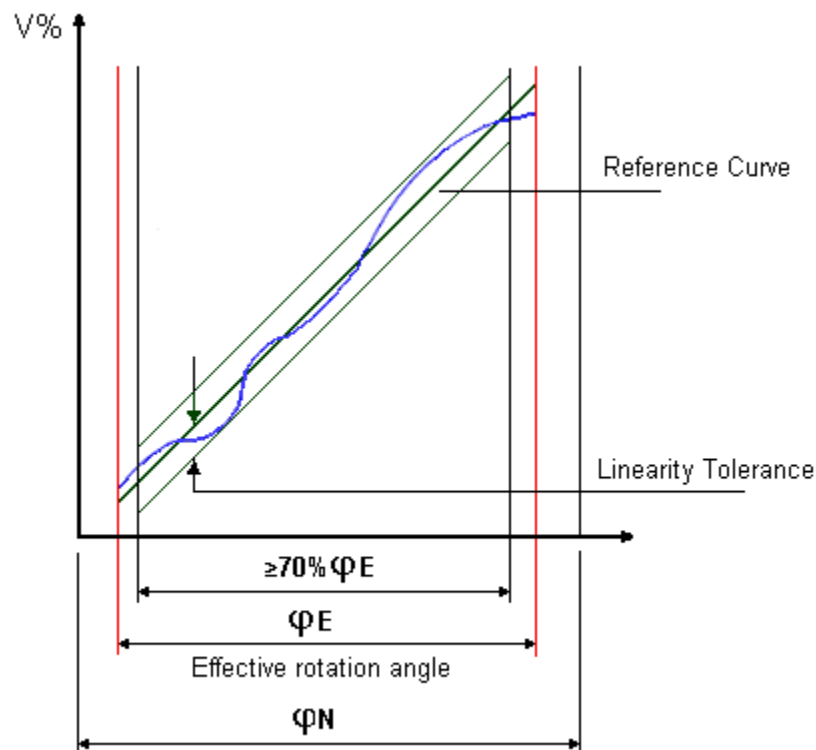

#### Matching Tolerance (For Tandem Stereo Potentiometers)

Tandem Potentiometers have two identical resistor units with the same variation law. The mismatching of the two resistor units, expressed in dB, is measured by the difference between the attenuations introduced by each resistor unit at various points of travel.

- Law A: 4 dB at Attenuation range 0 - 20 dB
- Law B and C: 3 dB at Attenuation range 0 - 20 dB

### Matched Tolerance for Stereo

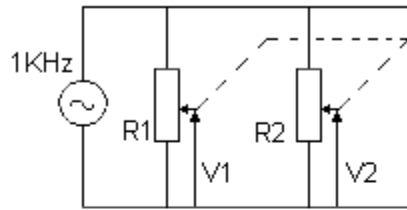

LAW	ATTENUATION RANGE	MATCHING TOLERANCE *
A	0 - 20dB	4dB
B & C	0 - 20dB	3dB

\*Matching Tolerance =  $20 \text{ Log } \frac{V1}{V2}$

Operating Temperature: -25°C to +70°C

### Temperature Derating Curve

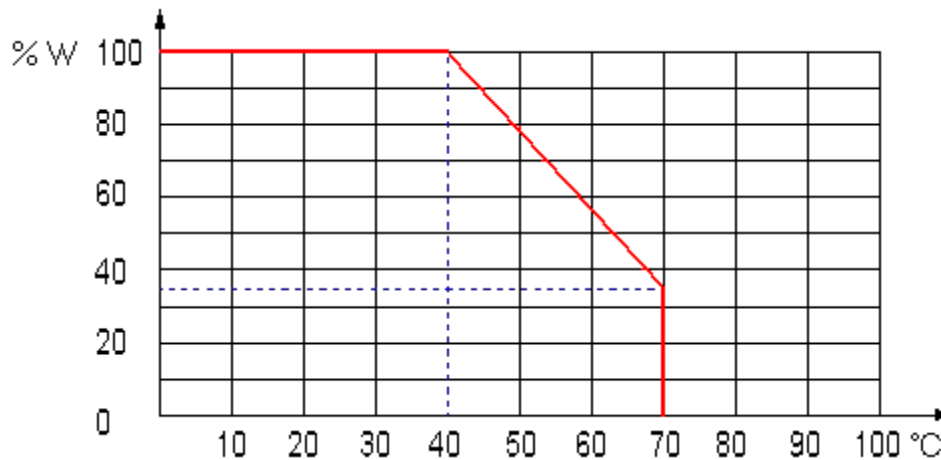

Temperature Coefficient of Resistance: +300 -500 ppm

## Components

### ECO Bush Housing (Mounting)

The ECO bush housing is made of glass filled nylon, the thread is M10 x0.75mm pitch and 8mm long, alternatively **a 12mm long thread is also available** from October 2008.

Do not attempt to prevent any unwanted body rotation by overtightening the retaining nut, since this can cause thread damage, distortion, change of electrical resistance and restrict shaft rotation. BS9130:1972 provides further details on this topic. The **recommended torque** for tightening the retaining nut is 45cN.m and this can be achieved cost effectively by using a Torque Limiting device as shown on our **Accessories** page.

GLASS FILLED NYLON

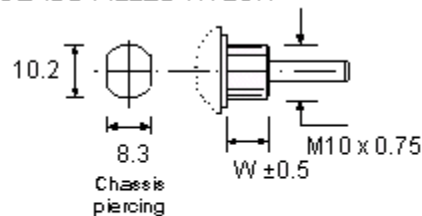

TYPE PLASTIC BODY	
W(mm)	8 (optional 12)

### ECO Spindles

The ECO plastic spindles are fixed and not removable.  
They are available in the following three diameters:

- 6.0mm Diameter - Length (L) available from 14mm to 65mm
  - Cylindrical (Type F1)
  - 4.0 x 12mm Flat (Type F2)
  - 5.0 x 15mm Flat (Type F3)
  - 5.0 x 10mm Flat (Type F4)
  - 4.6mm x 15mm Flat (Type F11)
  - 4.0 x 8mm Flat (Type F13)
  - 5.0 x 8mm Flat (Type F14)
- 4.0mm Diameter - Length (L) available from 14mm to 35mm
  - Cylindrical (Type F21)
  - 3.0 x 8.5mm Flat (Type F22)
- 6.35mm Diameter - Length (L) available from 14mm to 65mm
  - Cylindrical (Type F41)
  - 5.5 x 10mm Flat (Type F42)

### Cylindrical and Flatted Spindles

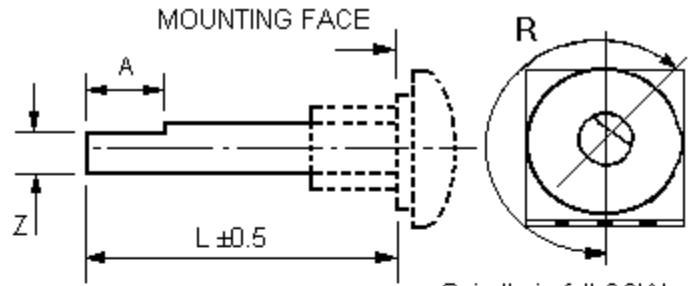
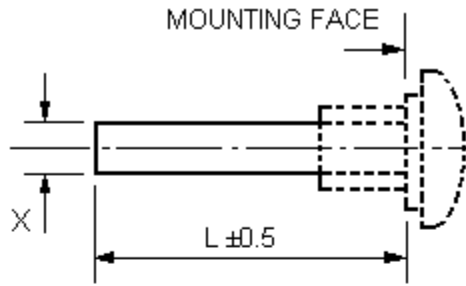

Spindle in full CCW position

TYPE	DESC. (∅)	L (mm)
F21	4 mm Dia Plastic	14 - 35
F1	6 mm Dia Plastic	14 - 65
F41	6.35mm Dia Plastic	14 - 65

All spindles fixed.

TYPE	DESC. (∅)	L (mm)	Flat (ZxA)
F22	4 mm Dia Plastic	14 - 35	3 x 8.5
F13	6 mm Dia Plastic	14 - 65	4 x 8
F2	6 mm Dia Plastic	14 - 65	4 x 12
F14	6 mm Dia Plastic	14 - 65	5 x 8
F4	6 mm Dia Plastic	14 - 65	5 x 10
F3	6 mm Dia Plastic	14 - 65	5 x 15
F11	6 mm Dia Plastic	14 - 65	4.6 x 15
F42	6.35mm Dia Plastic	14 - 65	5.5 x 10

Standard flat angle  
R = 210°

### Splined Spindle (6.0mm diameter)

A splined form is also available on the 6.0mm diameter ECO plastic spindle.

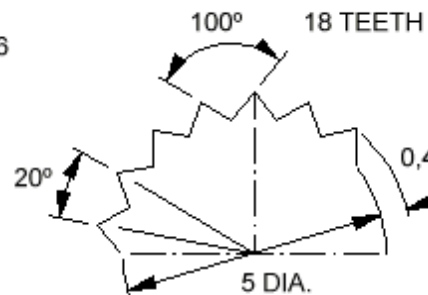
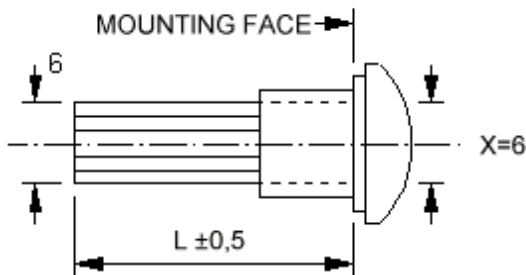

TYPE	DESC.	L (mm)
F5	Plastic Fixed	14 - 30